

Linear LED Fixture Spec Sheet

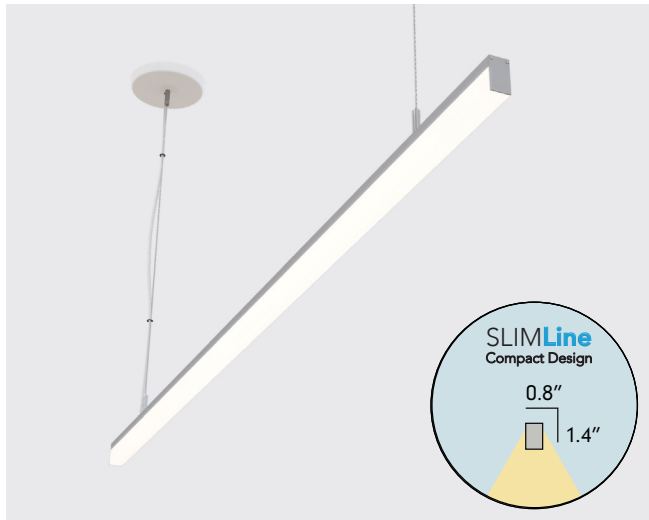

Our **LVLBPH** is a slim and attractive suspended (pendant) mounted linear light fixture available in custom sizes and configurations from **2-6.5ft**. Easily suspend from any ceiling type using the provided suspension kits. Sleek and attractive linear form makes this an attractive option for offices, retail stores, conference rooms, residences, and hotels.

Conveniently choose from a wide variety of colors, and custom sizes up to 78" in order to obtain fully personalized lighting that is tailored to your desired lighting applications.

Features

- 12-24VDC Input.
- 0-10V **Dimmable**.
- 80+ **CRI** Standard, 90+ available.
- 500 **lumens/ft**.
- Suspension Kits Included!
- **Waterproof Available Upon Request.**
- Made in the **USA** Quick Ship!
- **UL-Listed.**

Typical Lumen Table

Product Size	SO
2ft	969 LM / 10W
4ft	1,857 LM / 19W
6ft	2,756 LM/ 28W
8ft	3,634 LM/ 37W

*Based on standard sizes with 4000K Color Temperature

Specifications

*[XX] denotes color temperature

Part#	LVLBPH-XX-YY-ZZ
Sizes	4ft, 6ft Custom
Input Voltage	12VDC or 24VDC
Light Output	SO: 485 Lumens/ft (White)
Efficiency	101 Lumens/Watt (White)
Color Rendering	>80 CRI, >90 CRI
Environment	Suitable for Dry or Damp Locations
Warranty	5-Year
Lifetime	70,000+Hours
Listings	UL-Listed
Dimming	0-10V Dimmable, Phase/TRIAC
Light Distribution	Down Light

Available Colors

*Custom Available Upon Request

Finish Options

Standard	Custom
Satin Aluminum	Ruby Red RAL #3003
	Traffic Yellow RAL #1023
	Bright Orange RAL #2009
	Island Skye RAL #6027
	Beige RAL #1001
	Sky Blue RAL #5015

*Extended lead times for custom RAL finishes. Any RAL color can be selected in addition to the one shown

Light Distribution

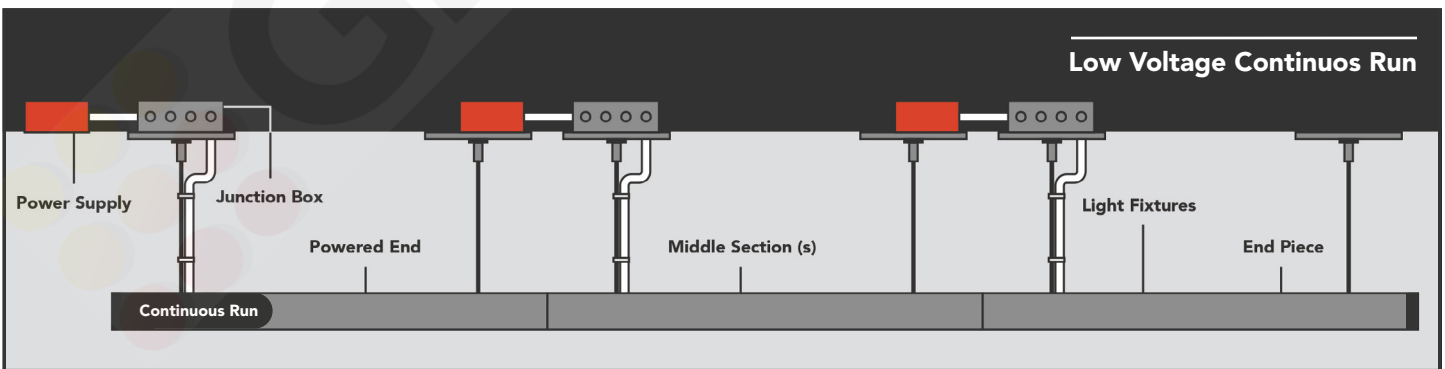
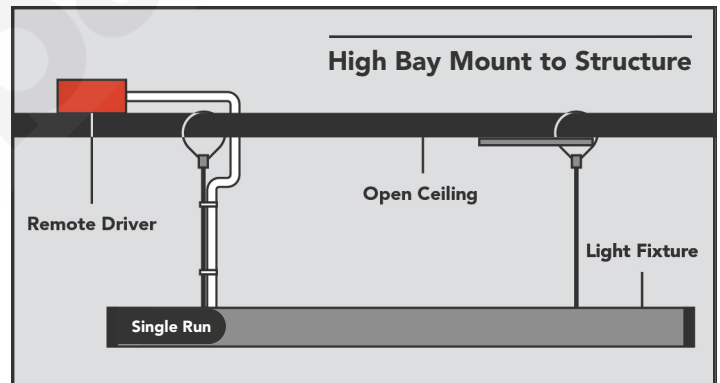
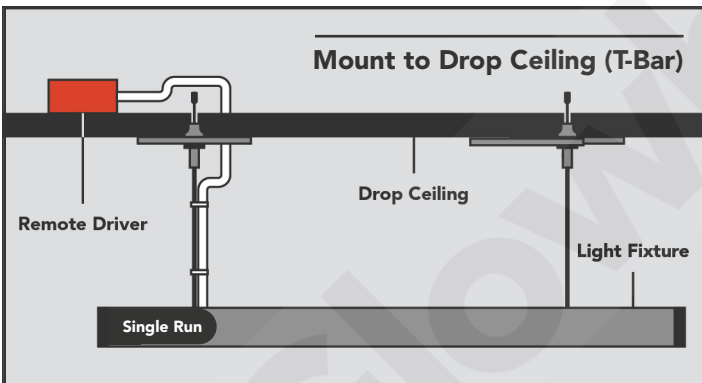
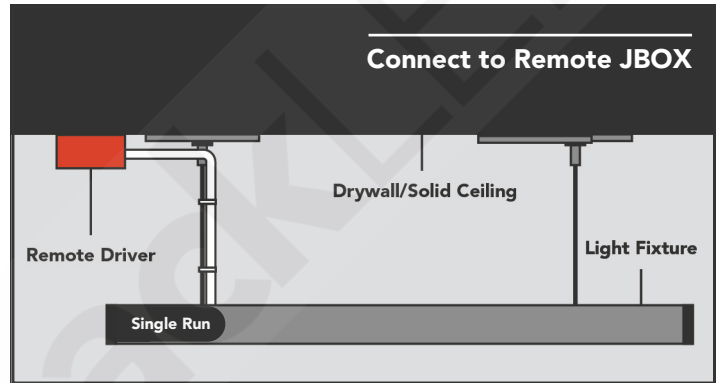
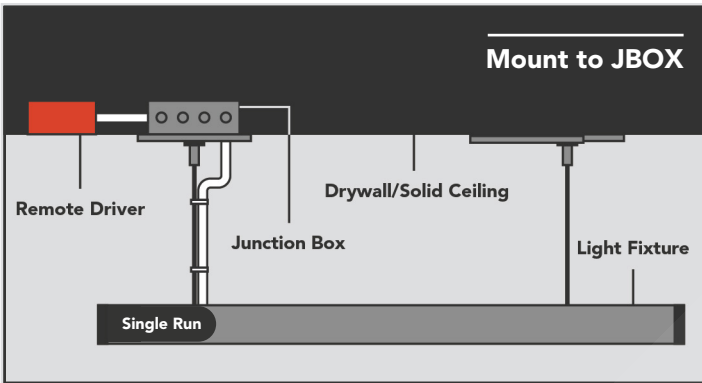
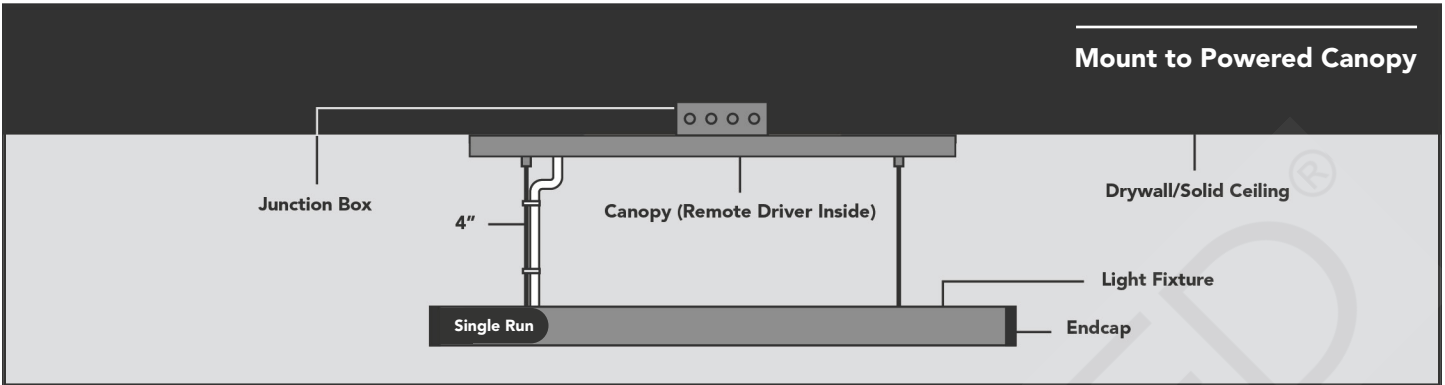

***Remote Power Supplies MUST be left accessible, they cannot be installed behind finished ceilings.**

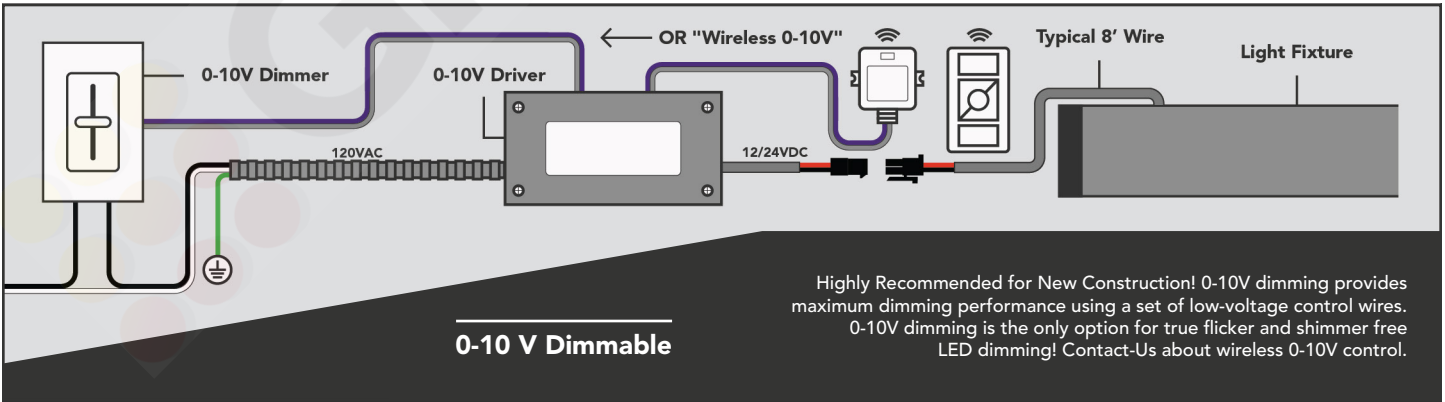
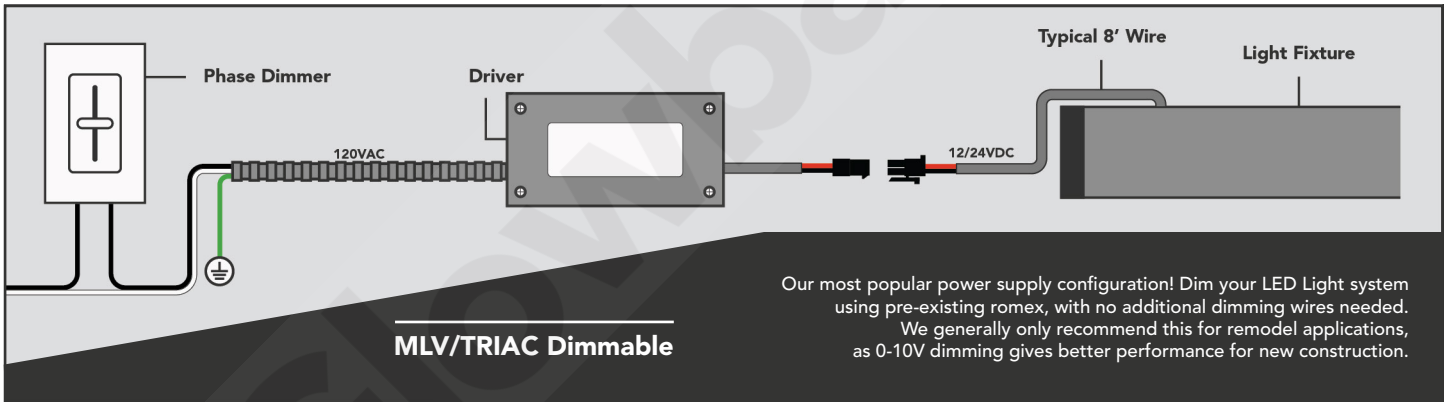
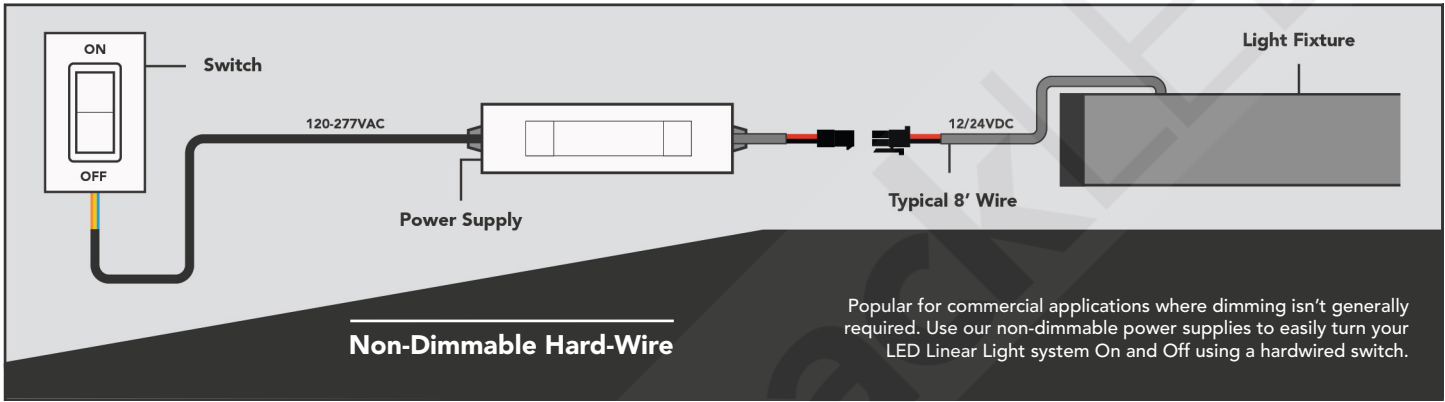
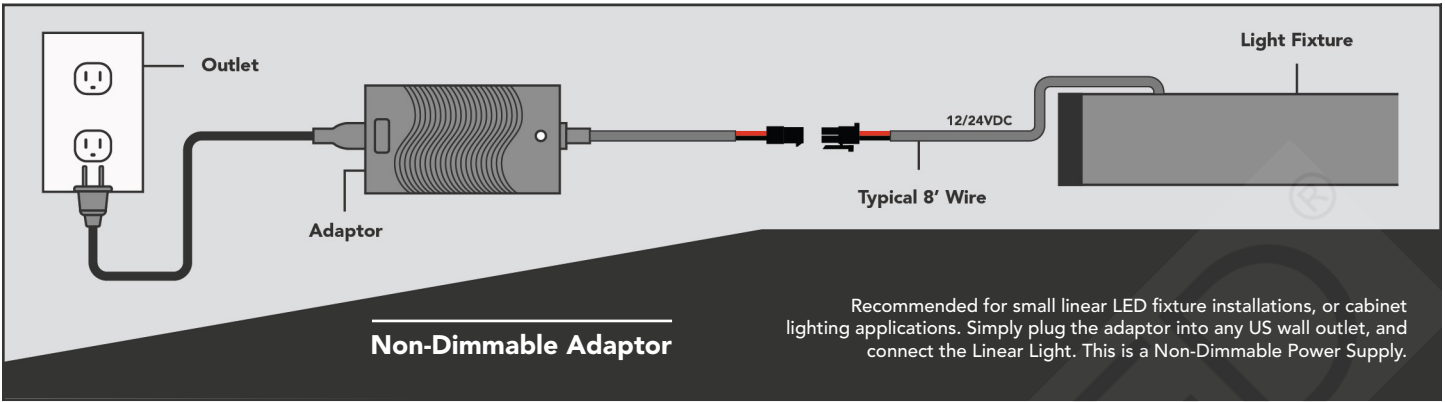

All of our LED Panels require a remote power supply and/or controller to operate. Seamlessly integrate our LED Panel systems with any type of home or building automation system. Unless otherwise specified, all LED Panel systems, including power supplies and controllers are shipped to you pre-configured, to facilitate installation. Power-Supplies will come "rigged" with connectors to match the connectors coming off the LED panels. When ordering, simply give us some details about the level of control that you want, and our team will design a turn-key control system fit to meet your needs.

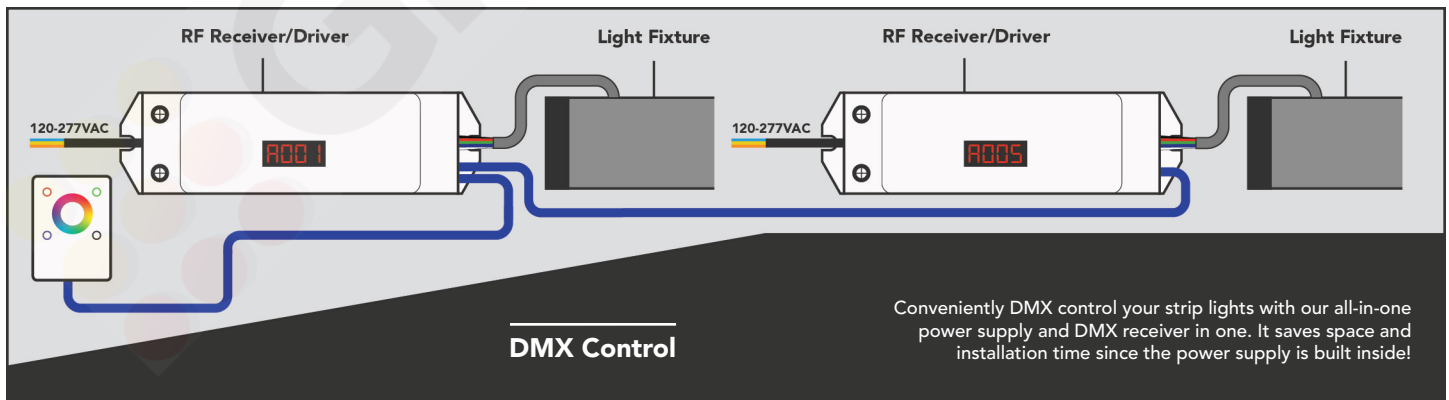
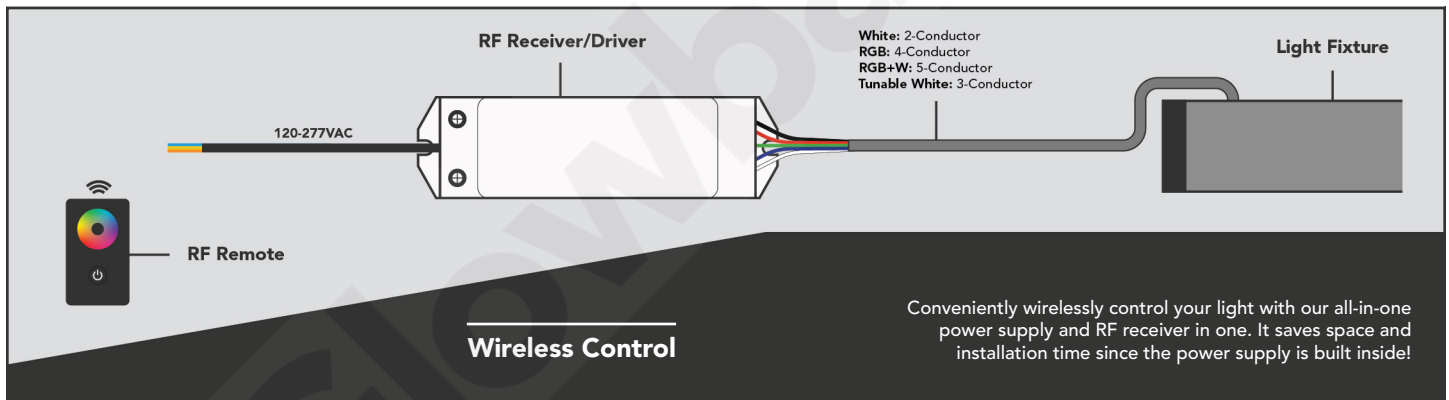
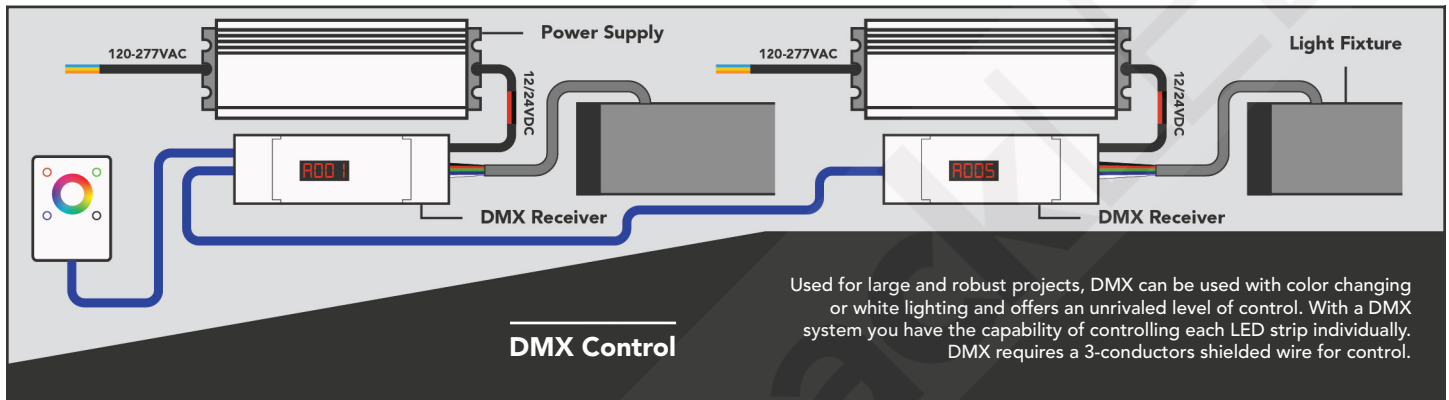
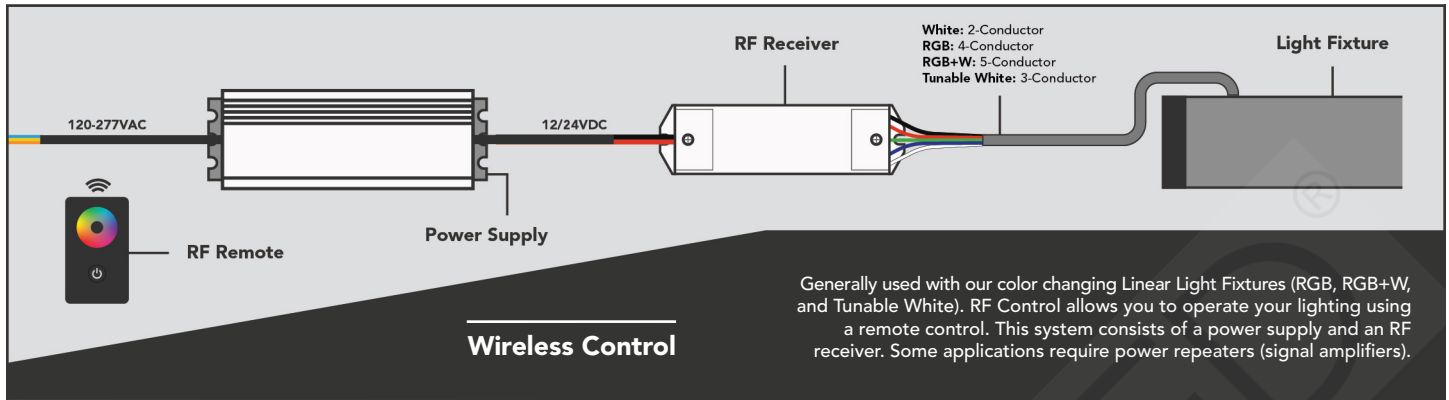

All of our LED Panels require a remote power supply and/or controller to operate. Seamlessly integrate our LED Panel systems with any type of home or building automation system. Unless otherwise specified, all LED Panel systems, including power supplies and controllers are shipped to you pre-configured, to facilitate installation. Power-Supplies will come "rigged" with connectors to match the connectors coming off the LED panels. When ordering, simply give us some details about the level of control that you want, and our team will design a turn-key control system fit to meet your needs.

Master Product Code Builder	
Prefix	LVLB
Profile	PH
Finish	
Satin Aluminum	leave blank
Matte Black	BLK
Matte White	N/A
Custom	C
Output	
485 Lumens/ft	SO
N/A	N/A
Size	
2ft	24
4ft	46
6ft	68
8ft	90
Custom	enter in inches
Continuous	CR
Custom Shape	CS
Color	
2300K	AW
2700K	IW
3000K	WW
4000K	NW
6000K	BW
Custom	enter CCT value
RGB+6000K	RGBW
RGB+2700K	RGBWW
Tunable White	CCT
CRI	
80+	80
90+	90
Mount Type	
Mount to JBOX	A
Remote JBOX	B
Drop Ceiling	C
High Bay	D
Voltage	
12VDC	leave blank
24VDC	24
Dimming/Control	
0-10V	leave blank
Phase/TRIAC	TRIAC
DMX	DMX
Run Type	
Single	leave blank
C/R Powered End	CRP
C/R Middle	CRM
C/R End Piece	CRE
NA	leave blank
Shapes	
NA	leave blank
Standard Shape	S/S
Custom Shape	C/S

Standard Shapes

L Configuration Rectangle/Square Configuration U Configuration

*More custom shapes are available upon request

Custom Shapes

X Configuration T Configuration Hexagon Configuration Triangle Configuration Linear Abstract Configuration

*More custom shapes are available upon request

Controller and Power Supply Options

Non-Dimmable Adaptor	24V 36W	24V36WAPT
	24V 60W	24V60WAPT
Non-Dimmable Hardwire	24V 36W	24V36WHOD
	24V 96W	24V4ALP13
Phase Dimmable	24V 30W	MUD24V30W
	24V 60W	MUD24V60W
	24V 96W	MUD24V96W
	24V 192W (2 x 96W)	MUD24V192W
	24V 288W (3 x 96W)	MUD24V288W
0-10V/Triac Dimmable (All-in-One)	24V 60W	M01024V60W
	24V 96W	M01024V96W
	24V 192W (2 x 96W)	M01024V192W
	24V 288W (3 x 96W)	M01024V288W
	24V 384W (4 x 96W)	M01024V384W
Non-Dimmable Hardwire for RF/DMX	24V 96W MeanWell	MWHLG100H24A
	24V 150W* MeanWell	MWHLG150H24A
RF Receiver and Remotes	RF Receiver (12-24V Input)	BG1009FA
	Power Repeater (12-24V Input)	BG3002
DMX Receivers	DMX Receiver (12-24V Input)	BG2108FA-4CH
	DMX Receiver (12-24V Input) w/ XLR and RJ45 Connectors	BG2108A-M5-5
All-In-One Built in Power Supply Receivers	RF Receiver (100-277VAC Input) 96W	BG1009FA-96CVF-24
	DMX Receiver (100-277VAC Input) 96W	BG2108-96CVF-24
DMX Controllers	Single Zone RGB/RGBW Touch Panel	BG2812B
	3-Zone RGB/RGBW Touch Panel	BG2812-3(W)
	Programmable Single Zone Nicolaudie Stick GU2	STICKGU2
	Programmable Single Zone Nicolaudie Stick CW4	STICKCW4
	Programmable 10 Zone Nicolaudie Stick DE3	STICKDE3

